



# Enzo

## Floodlight

Luminaria que ayuda al ahorro de energía y reemplaza a la tecnología de iluminación tradicional, Su diseño permite una rápida instalación de diversas formas.

### CONFIGURACIÓN DE PRODUCTO

CODIGO FIJO	+	MODELO FIJO	+	POTENCIA	+	ANGULOS DE APERTURA	+	VOLTAJE	+	TEMP. COLOR
EVE		REFSL		300W 600W 900W 1200W		A: 10° E: 45° B: 15° F: 60° C: 30° G: 90° D: 40° H: 120°		BLANK= 100-277V~ HV= 340-480V~		30 40 50 65

### ENTREGA INMEDIATA

MODELO	EFICIENCIA	LUMENES
EVE-REFSL-300W-D-50	150	45,000
EVE-REFSL-600W-D-50		90,000
EVE-REFSL-900W-D-50		135,000
EVE-REFSL-1200W-D-50		180,000

### ICONOGRAFÍA



DIMEABLE  
0-10V

IP66



SOBREPONER  
TECHO, PARED, PISO



COLOR  
NEGRO

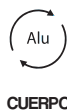

Alu  
CUERPO

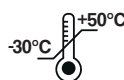

300W



600W

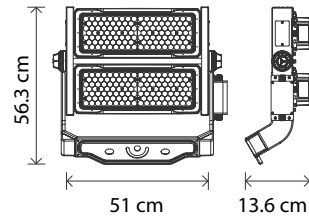

900W

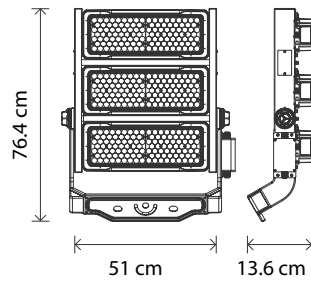

1200W

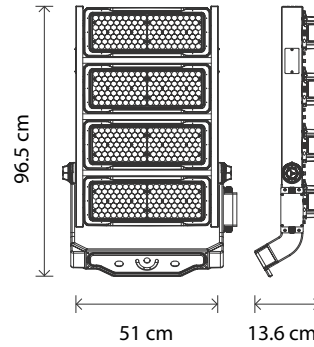

## Distribución fotométrica

20° grados

Fotometría

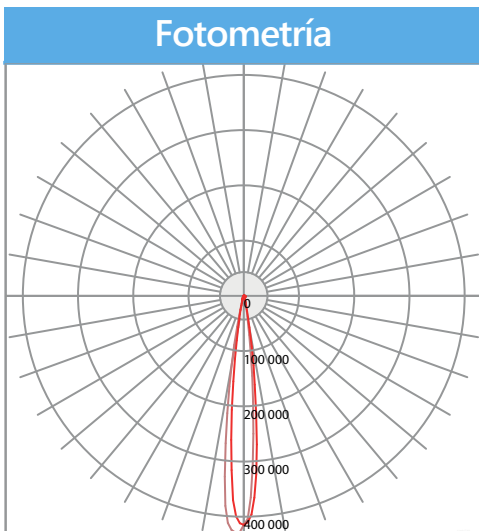

40° grados

Fotometría

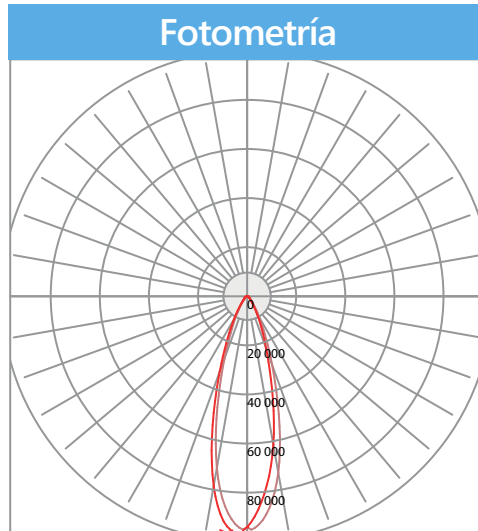

60° grados

Fotometría

